

# Quad 2-input NAND Schmitt trigger

## BU4093B / BU4093BF / BU4093BFV

The BU4093B, BU4093BF, and BU4093BFV are 4-circuit, 2-input NAND gates whose input pins all have a Schmitt trigger function.

As the circuit threshold voltages are different when the input waveform rises and when it falls ( $V_{IH}$ ,  $V_{IL}$ ), they can be used for line receivers, waveform rectification, multivibrators, and other purposes in addition to the customary usage as a NAND gate. They may be used in place of the BU4011B which uses the same pin connection.

### ●Features

- 1) Low power dissipation.
- 2) Wide range of operating power supply voltages.
- 3) High input impedance.
- 4) High fan-out.
- 5) Direct drive of 2 L-TTL inputs and 1 LS-TTL input.

### ●Block diagram

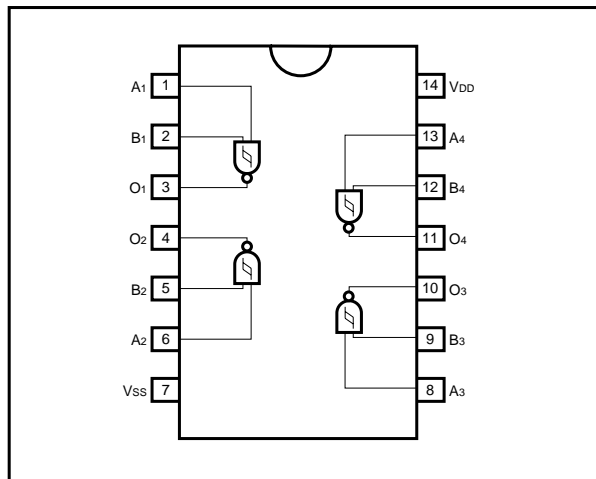

### ●Truth table

INPUT		OUTPUT
A	B	
L	L	H
L	H	H
H	L	H
H	H	L

●Absolute maximum ratings ( $V_{SS} = 0V$ ,  $T_a = 25^\circ C$ )

Parameter	Symbol	Limits	Unit
Power supply voltage	$V_{DD}$	- 0.3 ~ + 18	V
Power dissipation	$P_d$	1000 (DIP), 450 (SOP), 350 (SSOP)	mW
Operating temperature	$T_{opr}$	- 40 ~ + 85	$^\circ C$
Storage temperature	$T_{stg}$	- 55 ~ + 150	$^\circ C$
Input voltage	$V_{IN}$	- 0.3 ~ $V_{DD} + 0.3$	V

●Electrical characteristics

DC characteristics (unless otherwise noted,  $V_{SS} = 0V$ ,  $T_a = 25^\circ C$ )

Parameter	Symbol	Min.	Typ.	Max.	Unit	Conditions		Measurement circuit
						$V_{DD}$ (V)		
Input high level voltage	$V_{IH}$	3.5	—	—	V	5	—	Fig.1
		7.0	—	—		10		
		11.0	—	—		15		
Input low level voltage	$V_{IL}$	—	—	1.5	V	5	—	Fig.1
		—	—	3.0		10		
		—	—	4.0		15		
Input high level current	$I_{IH}$	—	—	0.3	$\mu A$	15	$V_{IH} = 15V$	Fig.1
Input low level current	$I_{IL}$	—	—	- 0.3	$\mu A$	15	$V_{IL} = 0V$	Fig.1
Output high level voltage	$V_{OH}$	4.95	—	—	V	5	$I_o = 0mA$	Fig.1
		9.95	—	—		10		
		14.95	—	—		15		
Output low level voltage	$V_{OL}$	—	—	0.05	V	5	$I_o = 0mA$	Fig.1
		—	—	0.05		10		
		—	—	0.05		15		
Output high level current	$I_{OH}$	- 0.44	—	—	mA	5	$V_{OH} = 4.6V$	Fig.1
		- 1.1	—	—		10	$V_{OH} = 9.5V$	
		- 3.0	—	—		15	$V_{OH} = 13.5V$	
Output low level current	$I_{OL}$	0.44	—	—	mA	5	$V_{OL} = 0.4V$	Fig.1
		1.1	—	—		10	$V_{OL} = 0.5V$	
		3.0	—	—		15	$V_{OL} = 1.5V$	
Static current dissipation	$I_{DD}$	—	—	1	$\mu A$	5	$V_i = V_{DD}$ or GND	Fig.1
		—	—	2		10		
		—	—	4		15		
Hysteresis voltage	$V_H$	0.17	—	0.39	V	5	—	Fig.3
		0.25	—	0.60		10		
		0.33	—	0.90		15		

Switching characteristics (unless otherwise noted,  $V_{SS} = 0V$ ,  $T_a = 25^\circ C$ ,  $C_L = 50pF$ )

Parameter	Symbol	Min.	Typ.	Max.	Unit.	V <sub>DD</sub> (V)	Conditions	Measurement circuit
						5		
Output rise time	t <sub>TLH</sub>	—	100	—	ns	5	—	Fig.2
		—	50	—		10		
		—	40	—		15		
Output fall time	t <sub>THL</sub>	—	100	—	ns	5	—	Fig.2
		—	50	—		10		
		—	40	—		15		
Propagation delay time, "L" to "H"	t <sub>PLH</sub>	—	125	—	ns	5	—	Fig.2
		—	50	—		10		
		—	40	—		15		
Propagation delay time, "H" to "L"	t <sub>PHL</sub>	—	125	—	ns	5	—	Fig.2
		—	50	—		10		
		—	40	—		15		
Input capacitance	C <sub>IN</sub>	—	5	—	pF	—	—	—

●Measurement circuits

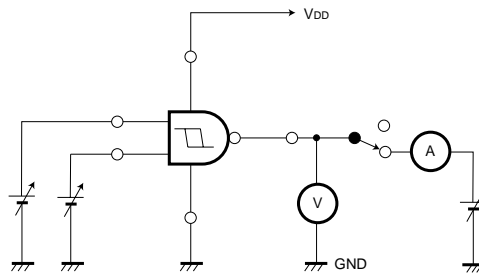

Fig. 1 DC characteristics

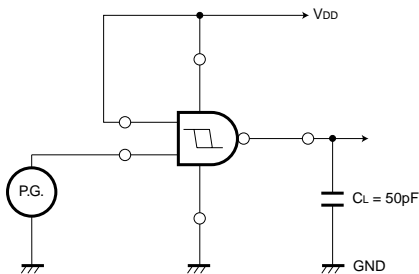

Fig. 2 Switching characteristic

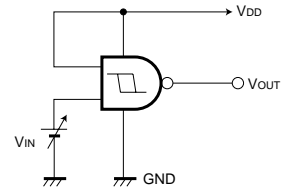
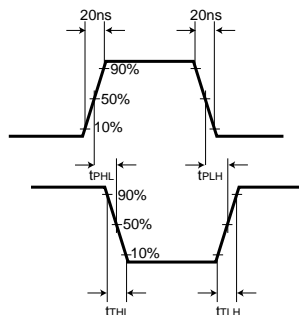

Fig. 3 Hysteresis voltage

●Electrical characteristic curve

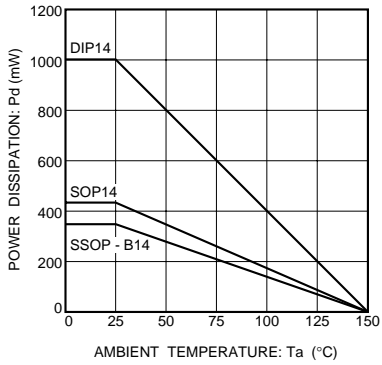
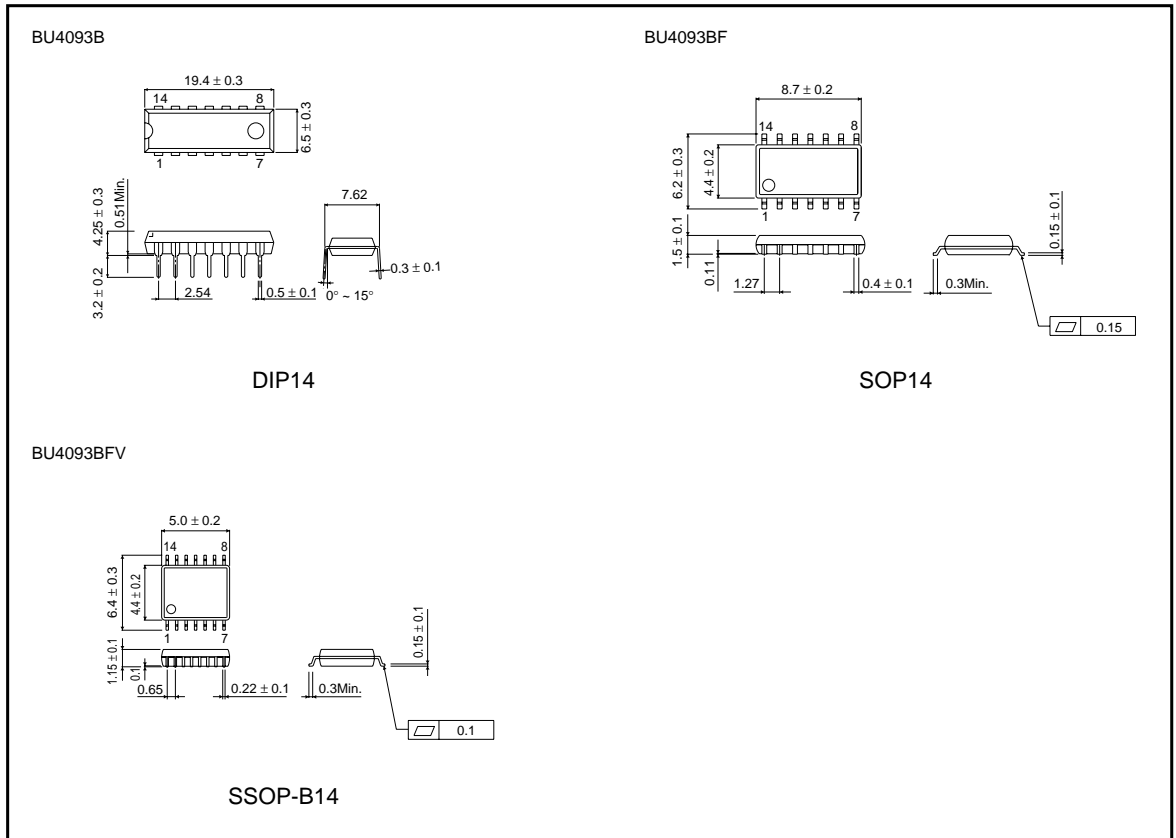

Fig. 4 Power dissipation vs. Ta

●External dimensions (Units: mm)



This datasheet has been downloaded from:

[www.DatasheetCatalog.com](http://www.DatasheetCatalog.com)

Datasheets for electronic components.